



# TMI-M990

## VGA IN-DASH MONITOR

- OWNER'S MANUAL  
Please read before using this equipment.

**IONBUS™**

# Contents

## Operating Instructions

### WARNING

WARNING .....	3
CAUTION .....	4
PRECAUTIONS .....	5

### Getting Started

About the Remote Control .....	6
About the indicators and the microphone ...	7
Using the TMI-M990 with an IONBUS connection .....	7
How to Read This Manual .....	8

### Basic Operation

Using Face Cover .....	9
Initial System Start-up .....	9
Turning Power On or Off .....	10
Opening/Closing the Monitor .....	12
Adjusting the Display Back and Forwards ...	13
Adjusting the Monitor Viewing Angle ...	14
Moving the Monitor to be Flat .....	15
Adjusting the Volume .....	15
Switching the Source .....	16
Switching Display Modes .....	17
Supplementary information .....	18

### Other Useful Features

About VISUAL EQ™ .....	20
Selecting the VISUAL EQ™ Property ..	21
Adjusting and Storing VISUAL EQ™ ...	23
About REAR SELECTOR .....	26
Rear Entertainment Function .....	28
Switching the Function of the Remote Sensor .....	29
Switching the Visual Source Only (Simultaneous Function) .....	30
Blackout Mode On and Off .....	31
Supplementary information .....	32

## Setup

About the Setup .....	33
General Setup Operation .....	34
Adjusting Brightness .....	36
Adjusting Color of Picture .....	36
Adjusting Tint of Picture .....	37
Adjusting Display Contrast .....	37
Adjusting the Sharpness .....	37
Storing the Adjusted VISUAL EQ .....	38
Setting the Illumination Brightness ...	38
Adjusting the Illumination Level .....	39
Illumination Control .....	39
Setting Automatic Opening/Closing of the Monitor .....	39
Selecting the Monitor Opening Angle ...	40
Adjusting the Monitor Viewing Angle ...	40
Sound (Beep) Guide Function .....	41
Changing Lighting Color .....	41
Navigation Interruption .....	41
Navigation Audio Interruption Volume Adjustment .....	42
Head Unit Linked Functions .....	42
AUX IN/S-IN SETUP .....	43
Setting the AUX Mode .....	44
Name External Equipment to Be Displayed (AUX) .....	45
External Input Audio Level Adjustment .....	45
Setting the S-IN Mode .....	45
Name the S Video Input to Be Displayed (S-IN) .....	45
<b>TV (Optional)</b> .....	
TV Operation .....	46

# Contents

## Operating from the Head Unit

Switching the Source .....	47
Adjusting the Volume .....	47
Operating the Head Unit with the Remote Control .....	48

## Information

In Case of Difficulty .....	49
Specifications .....	50

## Installation and Connections

Warning .....	51
Caution .....	52
Precautions .....	52
Installation .....	53
Connections (TMI-M990 Wiring Diagram) .....	56
System Example .....	58

## LIMITED WARRANTY

# WARNING



## WARNING

This symbol means important instructions. Failure to heed them can result in serious injury or death.

### **INSTALL THE PRODUCT CORRECTLY SO THAT THE DRIVER CANNOT WATCH TV/ VIDEO UNLESS THE VEHICLE IS STOPPED AND THE EMERGENCY BRAKE IS APPLIED.**

It is dangerous (and illegal in many states) for the driver to watch TV/Video while driving a vehicle. Installing this product incorrectly enables the driver to watch TV/Video while driving. This may cause a distraction, preventing the driver from looking ahead, thus causing an accident. The driver or other people could be severely injured.

### **DO NOT WATCH VIDEO WHILE DRIVING.**

Watching the video may distract the driver from looking ahead of the vehicle and cause an accident.

### **DO NOT OPERATE ANY FUNCTION THAT TAKES YOUR ATTENTION AWAY FROM SAFELY DRIVING YOUR VEHICLE.**

Any function that requires your prolonged attention should only be performed after coming to a complete stop. Always stop the vehicle in a safe location before performing these functions. Failure to do so may result in an accident.

### **KEEP THE VOLUME AT A LEVEL WHERE YOU CAN STILL HEAR OUTSIDE NOISE WHILE DRIVING.**

Failure to do so may result in an accident.

### **MINIMIZE DISPLAY VIEWING WHILE DRIVING.**

Viewing the display may distract the driver from looking ahead of the vehicle and cause an accident.

### **DO NOT DISASSEMBLE OR ALTER.**

Doing so may result in an accident, fire or electric shock.

### **USE ONLY IN CARS WITH A 12 VOLT NEGATIVE GROUND.**

(Check with your dealer if you are not sure.) Failure to do so may result in fire, etc.

### **KEEP SMALL OBJECTS SUCH AS BATTERIES OUT OF THE REACH OF CHILDREN.**

Swallowing them may result in serious injury. If swallowed, consult a physician immediately.

### **USE THE CORRECT AMPERE RATING WHEN REPLACING FUSES.**

Failure to do so may result in fire or electric shock.

### **DO NOT BLOCK VENTS OR RADIATOR PANELS.**

Doing so may cause heat to build up inside and may result in fire.

# WARNING

---

## **USE THIS PRODUCT FOR MOBILE 12V APPLICATIONS.**

Use for other than its designed application may result in fire, electric shock or other injury.

---

## **DO NOT PLACE HANDS, FINGERS OR FOREIGN OBJECTS IN INSERTION SLOTS OR GAPS.**

Doing so may result in personal injury or damage to the product.



## **CAUTION**

**This symbol means important instructions. Failure to heed them can result in injury or material property damage.**

---

## **HALT USE IMMEDIATELY IF A PROBLEM APPEARS.**

Failure to do so may cause personal injury or damage to the product. Return it to your authorized Alpine dealer or the nearest Alpine Service Center for repairing.

---

## **DO NOT MIX NEW BATTERIES WITH OLD BATTERIES. INSERT WITH THE CORRECT BATTERY POLARITY.**

When inserting the batteries, be sure to observe proper polarity (+ and -) as instructed. Rupture or chemical leakage from the battery may cause fire or personal injury.

---

## **KEEP FINGERS AWAY WHILE THE MOTORIZED FRONT PANEL OR MOVING MONITOR IS IN MOTION.**

Failure to do so may result in personal injury or damage to the product.



## PRECAUTIONS

---

### Product Cleaning

Use a soft dry cloth for periodic cleaning of the product. For more severe stains, please dampen the cloth with water only. Anything else has the chance of dissolving the paint or damaging the plastic.

---

### Temperature

Be sure the temperature inside the vehicle is between +45°C (+113°F) and 0°C (+32°F) before turning your unit on.

---

### Moisture Condensation

You may notice the disc playback sound wavering due to condensation. If this happens, remove the disc from the player and wait about an hour for the moisture to evaporate.

---

### Maintenance

If you have problems, do not attempt to repair the unit yourself. Return it to your Alpine dealer or the nearest Alpine Service Station for servicing.

---

### Installation Location

Make sure the TMI-M990 will not be installed in a location subjected to:

- Direct sun and heat
  - High humidity and water
  - Excessive dust
  - Excessive vibrations
- 
- After turning the system off, a slight ghost of the image will remain temporarily. This is an effect peculiar to LCD technology and is normal.
  - In cold temperature conditions, the screen may lose contrast temporarily. After a short warm-up period, it will return to normal.

---

Remove the anti-theft cover when you drive. This prevents the cover from falling off the unit and interfering with the safe operation of the vehicle.

---

Operation of some of the functions of this unit is very complex. Because of this, it was deemed necessary to place these functions into a special screen. This will restrict operation of these functions to times when the vehicle is parked. This ensures the focus of the driver's attention will be on the road and not on the TMI-M990. This has been done for the safety of the driver and passengers.

The Setup operation cannot be performed if the car is moving. The car must be parked and the parking brake must be engaged for the procedure described in the Owner's Manual to be valid. The warning "CAN'T OPERATE WHILE DRIVING," will be displayed if any attempts are made to perform these operations while driving. This operation is the same as when selecting sources using the remote control. When the car is parked, the selection is made as described in the Owner's Manual.

# Getting Started

## About the Remote Control

### Notes on Using the Remote Control

Point the remote control transmitter at the remote control sensor.

If connected to an IONBUS compatible head unit, even if you point the remote control at the remote control sensor on the head unit, the operation is received the same way.

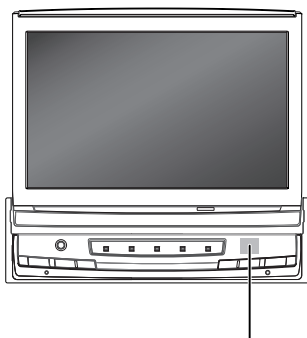

Remote control sensor

- Point the remote control at the remote sensor within about 2 meters.
- It may not be possible to operate the remote control unit if the remote control sensor is exposed to direct sunlight.
- The remote control is a small, light weight precision device. To avoid damage, short battery life, operational errors and poor button response, observe the following.
  - Do not subject to shock.
  - Do not put in a trouser pocket.
  - Keep away from food, moisture and dirt.
  - Do not place in direct sunlight.

### Battery Replacement

Applicable battery: Use two “AAA” sized dry batteries or equivalent.

- 1 Opening the battery cover.**  
Push on the cover and slide it as indicated by the arrows then the cover will be removed.

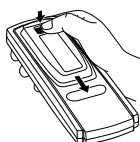

- 2 Replacing the battery.**  
Put the batteries in the case observing the polarity, as illustrated.

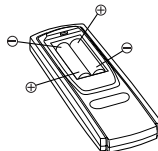

- 3 Closing the cover.**  
Push the cover in the arrow direction until a click is heard.

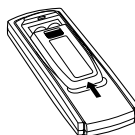

### Warning

**DO NOT OPERATE ANY FUNCTION THAT TAKES YOUR ATTENTION AWAY FROM SAFELY DRIVING YOUR VEHICLE.**

Any function that requires your prolonged attention should only be performed after coming to a complete stop. Always stop the vehicle in a safe location before performing these functions. Failure to do so may result in an accident.

## About the indicators and the microphone

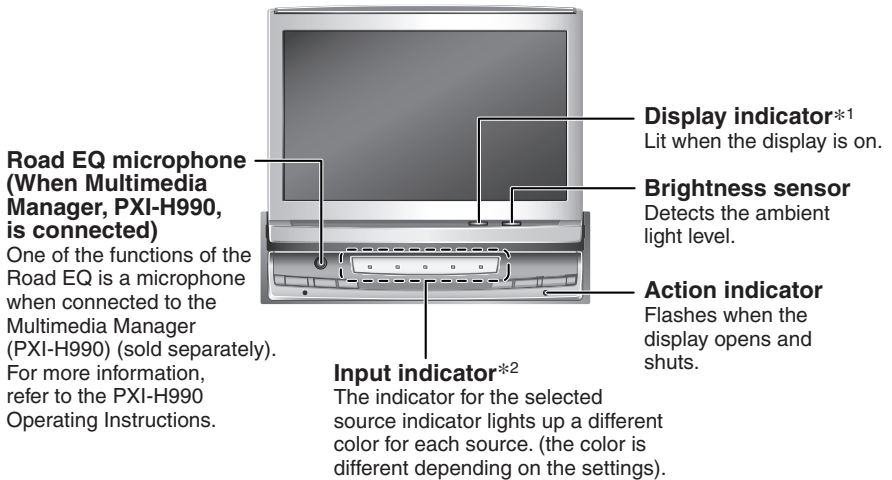

\*1 When AUTO is set for the “Illumination Control” (page 39), the light level corresponds to the detection of the Brightness sensor. So, when the ambient is dark, the indicator may not be lit.

\*2 You can set the color and brightness to your desired level.

(Refer to “Setting the Illumination Brightness” on page 38, “Changing Lighting Color” on page 41.)

## Using the TMI-M990 with an IONBUS connection

This unit connects to IONBUS compatible head units, and can even be operated from the head unit.

- For more information for operating from the head unit, refer to **Operating from the Head Unit** pages 47-48.
- To connect and use the IONBUS, turn the system switch on the main unit to “SYSTEM”. (See page 54).

### System switch

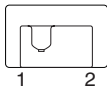

1:SYSTEM  
2:STANDALONE  
(Initial Setting)



# How to Read This Manual

This manual details how to operate the TMI-M990 and the supplied remote control RUE-4199.

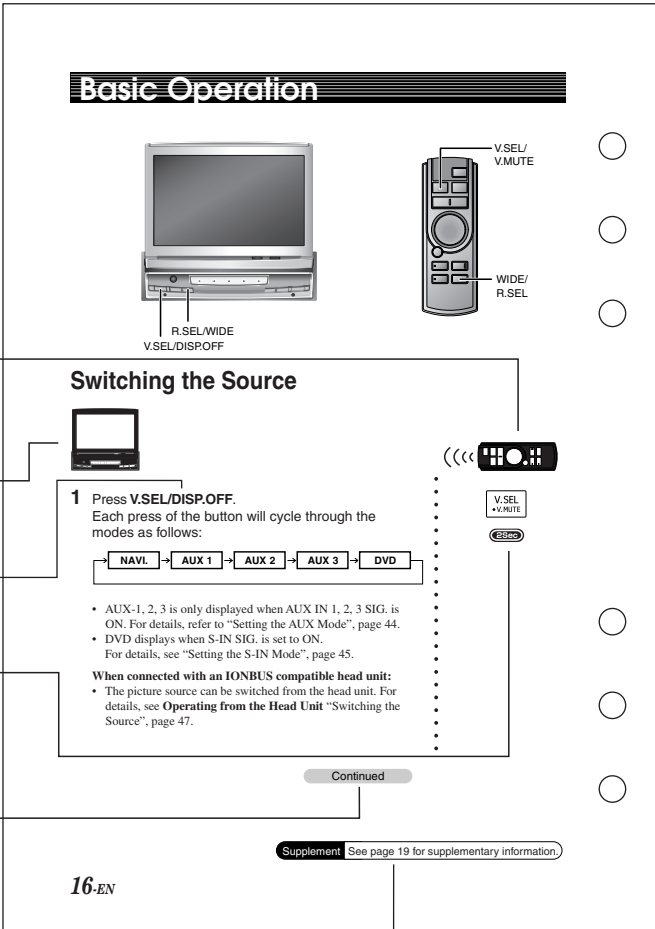

**Remote control icon**  
Indicates operations performed with the remote control unit.

**Main unit icon**  
Indicates operations performed on the main unit.

**Button name**  
Buttons to be operated are indicated in bold.

**1Sec/2Sec icon**  
Indicates that the specified remote control button should be pressed and held for over 1 or 2 seconds.

**Continued (Next page)**  
Indicates that the description of the operation continues on the next page.

**Supplement icon**  
Indicates that there is supplementary information on another page.

## Basic Operation

### Switching the Source

**1** Press **V.SEL/DISP.OFF**.  
Each press of the button will cycle through the modes as follows:

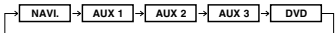

- AUX-1, 2, 3 is only displayed when AUX IN 1, 2, 3 SIG. is ON. For details, refer to "Setting the AUX Mode", page 44.
- DVD displays when S-IN SIG. is set to ON. For details, see "Setting the S-IN Mode", page 45.

**When connected with an IONBUS compatible head unit:**

- The picture source can be switched from the head unit. For details, see **Operating from the Head Unit** "Switching the Source", page 47.

Continued

Supplement See page 19 for supplementary information

16-EN

## Using Face Cover

An anti-theft face cover is provided with the TMI-M990.  
Put the face cover onto the TMI-M990 when you leave the vehicle.  
Be sure to remove the anti-theft face cover when you drive.



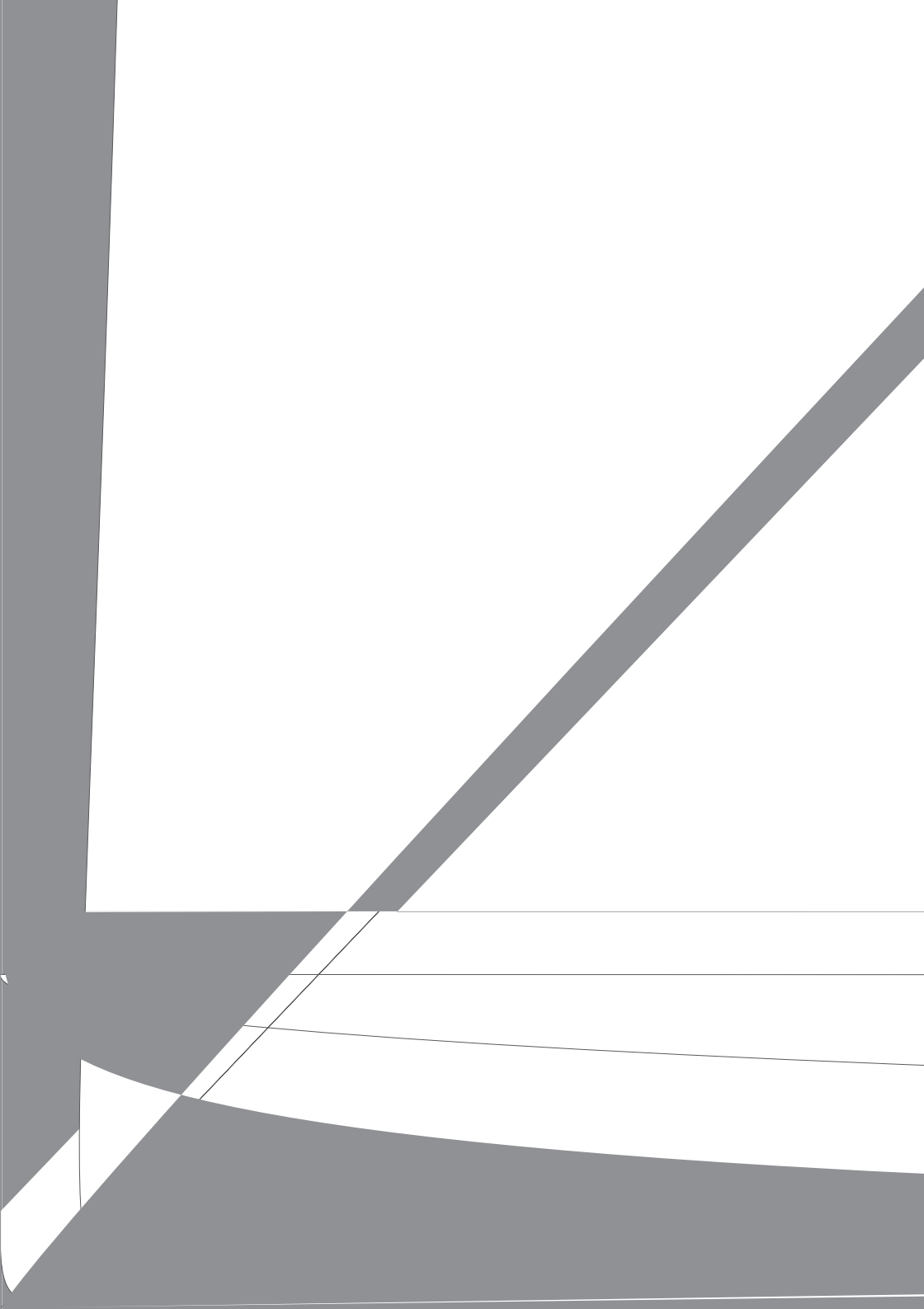

## 2 Press and hold **V.SEL/DISP.OFF** for at least 2 seconds to turn off the unit.

- The unit can be turned on by pressing any one of the buttons **V.SEL/DISP. OFF**, **VISUAL EQ** or **R.SEL/WIDE**.
- The TMI-M990 draws minimal current even when its power switch is turned off. If the switched power (ignition) lead of the TMI-M990 is connected directly to the positive (+) post of the vehicle's battery, the battery may be discharged. If this lead is unswitched, it must be disconnected from the battery post should the vehicle be left unused for an extended period of time.

An SPST (Single-Pole, Single-Throw) switch (sold separately) can be added to simplify this procedure. Then, you can simply place it in the OFF position when you leave the vehicle. Turn the SPST switch back ON before using the TMI-M990. For connecting the SPST switch, refer to the "Connection Diagram of SPST Switch" (page 55).

- Some operation of the unit cannot be performed while the vehicle is in motion. In this case, be sure to first stop your vehicle and apply the parking brake, then perform the operation.

### **When the TMI-M990 is connected to an IONBUS compatible head unit:**

- The TMI-M990 power is linked to the head unit. When the head unit is switched on, the TMI-M990 is also switched on, and when the head unit is switched off, the TMI-M990 is also switched off.

For details, refer to the head unit Operating Instructions.

- The power cannot be switched off from the TMI-M990.
- When the system switch on this unit is set to **STANDALONE**, the power will not turn on. You must set to **SYSTEM**. (See page 54)

POWER

Supplement See page 18 for supplementary information.



VISUAL EQ

∨/TILT  
∧/TILT

OPEN/CLOSE /  
SETUP



BAND/  
SETUP



▲/FLAT

▼/O/C

- If the display stops during opening/closing, then press **OPEN/CLOSE / SETUP** again. If it still does not move, then contact your Alpine dealer. Do not force the display. You may damage your TMI-M990.
- The display activates using the values stored for angle adjustment and back and forward adjustment.  
See “Adjusting the Display Back and Forwards” (this page), and “Adjusting the Monitor Viewing Angle” (page 14).

**Supplement** See page 18 for supplementary information.

## Adjusting the Display Back and Forwards

The monitor opening angle can be set in 2 positions.



- 1 Press and hold **OPEN/CLOSE / SETUP** for at least 2 seconds while the display is out.

- 2 Press **OPEN/CLOSE / SETUP** or **VISUAL EQ** and select SLIDE.  
When you press **OPEN/CLOSE / SETUP**, you move to the next item, press **VISUAL EQ** to move to the previous item.

- 3 Press  $\nabla$  / **TILT** or  $\wedge$  / **TILT**, and select **BACK** or **FRONT**.  
The display can slide about 1 cm back and forwards.

- 4 When you have finished adjusting, press and hold **OPEN/CLOSE / SETUP** for at least 2 seconds.



BAND  
• SETUP

2Sec



• FLAT  
○ ▲  
TILT  
• 0/C  
○ ▼

BAND  
• SETUP

2Sec

# Basic Operation

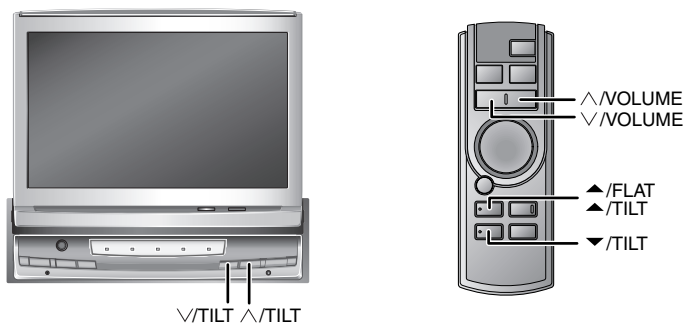

## Adjusting the Monitor Viewing Angle

Adjust the monitor's angle for better visibility.



- 1 Press  $\surd$  / TILT and  $\wedge$  / TILT to adjust the monitor's angle so the screen will be in the best viewing position. Pressing the buttons produces a beep and changes the screen angle between about 40 and 105 degrees.

- By pressing and holding  $\surd$  / TILT or  $\wedge$  / TILT, the angle changes continuously.
- You can also adjust the display angle by selecting from one of 10 levels.

For details, see the **Setup operation** "Adjusting the Monitor Viewing Angle" on page 40.

- The adjustment angle is stored, but depending on the motion, the position can be shifted from the original position.

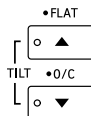

Supplement See page 19 for supplementary information.

# Moving the Monitor to be Flat

When you want to operate some function on the car (air conditioner, etc.) which is hidden by the raised monitor, use this function.

 The following operation is performed with the supplied remote control.

**1** Press and hold **▲/FLAT** for at least 2 seconds.  
The monitor moves to the flat position.

---

**2** Press and hold **▲/FLAT** again for at least 2 seconds.  
The monitor returns to the previous angle.

- The monitor returns to the previous angle from being flat after 10 seconds.
- If an excessive force is added to the monitor when the monitor is flat, putting an object on the back of the monitor for example, it may cause a malfunction.

# Adjusting the Volume

 The following operation is performed with the supplied remote control.

**1** Press **∨ / VOLUME** or **∧ / VOLUME** to adjust the volume.  
Adjust the volume output to the Amplified Speaker that is connected to the AUX Audio Output (AUX OUT 1) Terminal.

- The volume changes continuously if **∨ / VOLUME** or **∧ / VOLUME** is held down.
- The volume can be adjusted for each source.

**When connected with an IONBUS compatible head unit:**

- The volume adjustment is performed at the head unit. For details, see **Operating from the Head Unit** “Adjusting the Volume”, page 47.

Supplement See page 19 for supplementary information.



# Basic Operation

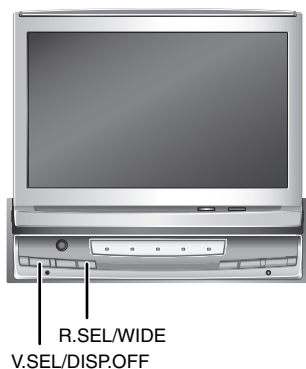

## Switching the Source



- 1 Press **V.SEL/DISP.OFF**.  
Each press of the button will cycle through the modes as follows:

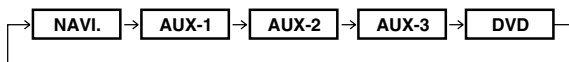

- AUX-1, 2, 3 is only displayed when AUX IN 1, 2, 3 SIG. is ON. For details, refer to “Setting the AUX Mode”, page 44.
- DVD displays when S-IN SIG. is set to ON. For details, see “Setting the S-IN Mode”, page 45.

### When connected with an IONBUS compatible head unit:

- The picture source can be switched from the head unit. For details, see **Operating from the Head Unit** “Switching the Source”, page 47.

V.SEL  
• V.MUTE

Supplement See page 19 for supplementary information.

# Switching Display Modes



- 1 Press and hold **R.SEL/WIDE** for at least 2 seconds in the visual source.  
Each press changes the display modes as follows:

In Normal mode, the monitor displays a normal picture at the center of the screen with a vertical black band at each side.

In Wide mode, the monitor displays a normal picture wider to fit in a wide-screen monitor by evenly stretching out the picture horizontally.

In Cinema mode, the monitor displays a normal picture by stretching out the picture horizontally and vertically. This mode is good for displaying a cinema type picture at the 16 : 9 ratio.

# Basic Operation

Supplementary information	This page includes supplementary information for pages 9 to 17. Please refer to these pages.	
TITLE	Description	Related page
Initial System Start-up	When reset, the stored contents are lost. Perform storage and adjustment one more time.	📖 Page 9
	If you reset when the display is open, then the display is automatically closed.	📖 Page 9
	If you reset while the display is opening, the backlight briefly lights up, but this is not a fault.	📖 Page 9
Turning Power On or Off	The power does not switch off by simply closing the display.	📖 Page 10
	The TMI-M990 stores the state before the ignition key switches off. For example, if the ignition key is switched from OFF to ON in NAVI. mode, then the NAVI. mode is activated.	📖 Page 10
Opening/Closing the Monitor	If <b>OPEN/CLOSE / SETUP</b> is pressed while the display is moving, then it stops. When it stops, press <b>OPEN/CLOSE / SETUP</b> again.	📖 Page 12
	The display automatically opens/closes depending on the status of the ignition key (engine key). For the setup operation, "Setting Automatic Opening/Closing of the Monitor", page 39.	📖 Page 12
	The display can be opened even when the power is off, but the power will not automatically turn on. See "Turning Power On or Off" (page 10) to turn on the power.	📖 Page 12
	Under cold temperature conditions, the screen may lose contrast temporarily. After a short warm-up period, it will return to normal.	📖 Page 12
	In low ambient temperature conditions, the display may be dark for a short period of time immediately after the power is turned on. Once the LCD has warmed up, the display returns to normal.	📖 Page 12

TITLE	Description	Related page
Adjusting the Monitor Viewing Angle	If the monitor touches an obstacle while the angle is being adjusted, the unit stops the screen immediately. Should this happen, remove the obstacle and press $\nabla$ / <b>TILT</b> or $\wedge$ / <b>TILT</b> again.	
	The screen color will vary when viewed at certain angles. Adjust the screen angle for the best viewing position.	
	If the voltage of the vehicle's battery power is low, the screen may blink when the screen angle is changed. This is normal and not a malfunction.	
	The display angle is also allowed to adjust while turning power off.	
Adjusting the Volume	The factory settings for the sound volume is minimum.	
Switching the Source	In the AUX mode, if you press <b>BAND/SETUP</b> on the supplied remote control, you can change between AUX-1, 2, 3.	
Switching Display Modes	In the setup screen, etc., the display mode enters Wide mode. After exiting from the setup operation, the display mode returns to the original display mode.	
	In the navigation screen, the display mode is not allowed to be switched.	

# Other Useful Features

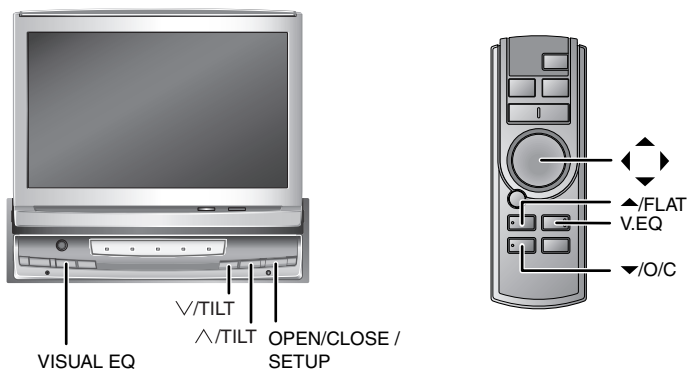

## About VISUAL EQ™

### To display the Setup screen:

To watch a video source, your vehicle must be parked with the ignition key in the ACC or ON position. To do this, follow the procedure below.

1. Bring your vehicle to a complete stop at a safe location. Engage the parking brake.
2. Keep pushing the foot brake and release the parking brake once then engage it again.
3. When the parking brake is engaged for the second time, release the foot brake.

- For automatic transmission vehicles, place the transmission lever in the Park position.

Now, the locking system for the Setup operation has been released. Engaging the parking brake can reactivate the Setup, as long as the car's ignition has not been turned off. It is not necessary to repeat the above procedure (1 through 3), of "To display the Setup screen."

Each time the ignition is turned OFF, perform the procedure of "To display the Setup screen."

Use VISUAL EQ to create the best image by compensating for the ambient light conditions, then store your settings on the TMI-M990.



- 1 Select VISUAL EQ ON mode by pressing **VISUAL EQ.**

**VISUAL EQ ON** ⇄ OFF

V.EQ

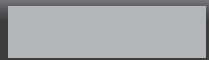

# Other Useful Features

- When VISUAL EQ is ON, the selected VISUAL EQ property name is displayed. (See page 20)
- “OFF” is set on this unit when the power is first turned on. Press **VISUAL EQ** to display “FLAT”.

**2** Press and hold **VISUAL EQ** for at least 2 seconds. The VISUAL EQ SETUP screen is displayed.

V.EQ 0

2Sec

**3** Press **OPEN/CLOSE / SETUP** and select VISUAL EQ.



**4** Select your preferred VISUAL EQ property with either  $\nabla$  / **TILT** or  $\wedge$  / **TILT**.

$\leftarrow$  FLAT  $\leftrightarrow$  NIGHT MOVIE  $\leftrightarrow$  SOFT  $\leftarrow$   
 $\leftarrow$  USER1/2  $\leftrightarrow$  HIGH CONTRAST  $\leftrightarrow$  SHARP  $\leftarrow$

- FLAT:** Flat image
- NIGHT MOVIE:** Brightens up a dark scene. Suitable for movies with a lot of dark scenes.
- SOFT:** Suppresses screen glare. Suitable when watching CG or animation.
- SHARP:** Sharpens the picture. Suitable when the picture is not clear.
- HIGH CONTRAST:** Increases the screen contrast. Suitable for new movies.
- USER 1/2:** Accesses the adjustment value stored in “Adjusting and Storing VISUAL EQ™” (Page 23).

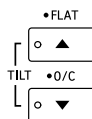

**5** Press and hold **VISUAL EQ** for at least 2 seconds. The screen returns to normal mode.

V.EQ 0

2Sec

- You can set VISUAL EQ for each picture source such as DVD.





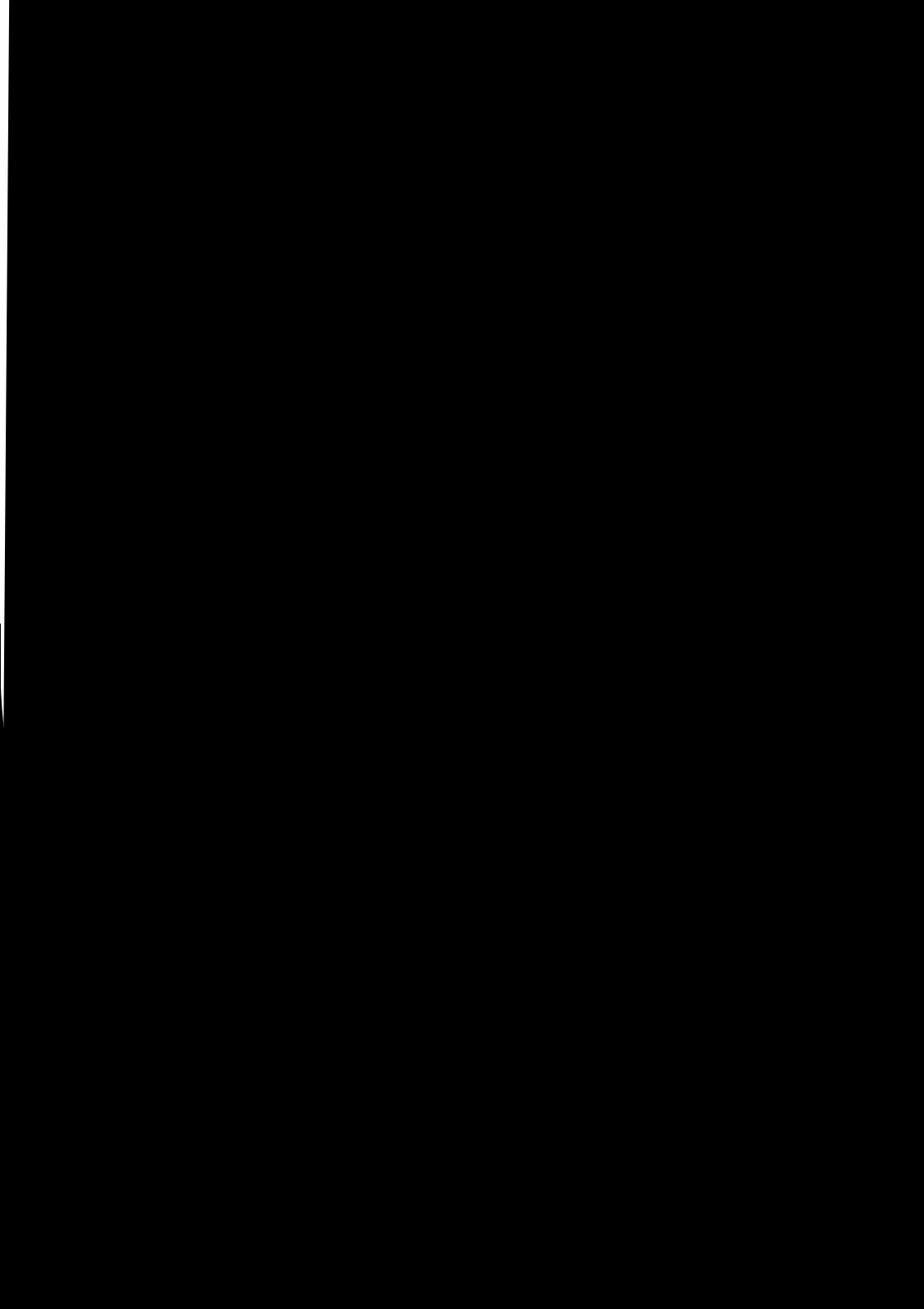

- 8** Press **V.SEL/DISP.OFF**.  
The stored adjustments are applied to the current video image.

V.SEL  
•V.MUTE

- 
- 9** After setting, press and hold **VISUAL EQ** for at least 2 seconds.  
The screen returns to the previous one.

V.EQ 0

2Sec

- To recall the stored adjustment values, see “Selecting the VISUAL EQ™ Property” (page 21).
- After selecting the manufacturer’s setting of VISUAL EQ property (NIGHT MOVIE etc.), the property can be adjusted and saved. While adjusting, CUSTOM is displayed.

Supplement See page 32 for supplementary information.



- When you press **DISP./A.MEMO** on the remote control unit, the current status is displayed.  
The displayed items are the source (page 16), the display mode (page 17), the **MEMO** (page 18), the EQ property (page 21) other than the rear monitor status.

See page 32 for supplementary information.

Rear monitor 1 (AUX OUT1),  
Rear monitor 2 (AUX OUT2)  
status (page 8)

Remote control output display  
When rear monitor is in the remote control  
operating mode

# Other Useful Features

## Rear Entertainment Function

The rear entertainment function independently routes different sources to the front and the rear of the car. For example, while listening to the radio or other audio source in the front, DVD can be enjoyed in the rear with the optional rear monitor and headphones.

**Setting item: AUX OUT1, AUX OUT2**

AUX OUT1\*<sup>1</sup>: Select the source, from the list below, that is output to AUX OUT1.

AUX OUT2: Select the source, from the list below, that is output to AUX OUT2.

**Setting content: LINK, NAVI., AUX-1, AUX-2, AUX-3, DVD**

LINK: The picture and sound being shown on the TMI-M990 is output to the rear monitor.

NAVI.: The picture and sound from the Navigation is output to the rear monitor. (Only when the Navigation is connected.)

AUX-1\*<sup>2</sup>: Any A/V source unit (TV, VCR, Video Game, etc.)

AUX-2\*<sup>2</sup>: Any A/V source unit (TV, VCR, Video Game, etc.)

AUX-3\*<sup>2</sup>: Any A/V source unit (TV, VCR, Video Game, etc.)

DVD\*<sup>3</sup>: The picture from the S video output compatible Alpine head unit is output to the rear monitor.

\*<sup>1</sup> If not connected to an IONBUS compatible head unit, AUX OUT1 is fixed to LINK. It is then used as audio output for the front (TMI-M990).

\*<sup>2</sup> Only displayed when AUX IN 1,2,3 SIG. ON. (See page 44)

\*<sup>3</sup> Only displayed when S-IN SIG. ON. (See page 45)

## Switching the Function of the Remote Sensor

The remote sensors of the external unit (monitor, etc.), can be selected for Remote control operation from the external unit.

**Setting item:** *REM.CON IN*

**Setting content:** *FRONT, REAR-1, REAR-2*

**FRONT:** The remote control sensor on the main unit is enabled. Remote control operation from any external monitor is disabled.

**REAR-1\*<sup>4</sup>:** The remote sensor of the external monitor connected to AUX OUT1 is enabled. Remote control operation of the source selected for AUX OUT1 only, is possible.

**REAR-2:** The remote sensor of the external monitor connected to AUX OUT2 is enabled. Remote control operation of the source selected for AUX OUT2 only, is possible.

\*<sup>4</sup> Can be set only when an IONBUS compatible head unit is connected.

- When set to REAR-1/2, remote control operation cannot be performed on the FRONT (TMI-M990). In this case, perform operation with the buttons of the TMI-M990 main unit.









# Other Useful Features

**Supplementary information** This page includes supplementary information for pages 20 to 31. Please refer to these pages.

TITLE	Description	Related page
Adjusting and Storing VISUAL EQ™	<p>Adjusting and storing of VISUAL EQ can also be made from the setup. The procedure is below. For more details, see the <b>General Setup Operation</b>.</p> <p><b>Operation from the main unit</b></p> <ol style="list-style-type: none"> <li>1 Press and hold <b>OPEN/CLOSE / SETUP</b> for at least 2 seconds.</li> <li>2 Press <b>VISUAL EQ</b> or <b>OPEN/CLOSE / SETUP</b>, and select an item to adjust from BRIGHT, COLOR, TINT, CONTRAST, SHARPNESS.</li> <li>3 Adjust the image by pressing <math>\nabla</math> / <b>TILT</b> or <math>\wedge</math> / <b>TILT</b>.</li> <li>4 When adjusting another item, repeat steps 2 and 3.</li> <li>5 When the picture settings are complete, press <b>VISUAL EQ</b> or <b>OPEN/CLOSE / SETUP</b> and select V.EQ MEMORY.</li> <li>6 Press <math>\nabla</math> / <b>TILT</b> or <math>\wedge</math> / <b>TILT</b> to select USER1 or USER2 mode.</li> <li>7 Press <b>V.SEL/DISP.OFF</b>. The image adjustments are stored in the selected mode.</li> <li>8 After setting, press and hold <b>OPEN/CLOSE / SETUP</b> for at least 2 seconds. The screen returns to the previous one.</li> </ol> <p><b>Operation from the remote control</b></p> <ol style="list-style-type: none"> <li>1 Press and hold <b>BAND/SETUP</b> for at least 2 seconds.</li> <li>2 Press <math>\blacktriangledown</math> or <math>\blacktriangle</math>, and select an item to adjust from BRIGHT, COLOR, TINT, CONTRAST, SHARPNESS.</li> <li>3 Adjust the image by pressing <math>\blacktriangleleft</math> or <math>\blacktriangleright</math>.</li> <li>4 When adjusting another item, repeat steps 2 and 3.</li> <li>5 When the picture settings are complete, press <math>\blacktriangledown</math> or <math>\blacktriangle</math> and select V.EQ MEMORY.</li> <li>6 Press <math>\blacktriangleleft</math> or <math>\blacktriangleright</math> to select USER1 or USER2 mode.</li> <li>7 Press <b>V.SEL/V.MUTE</b>. The image adjustments are stored in the selected mode.</li> <li>8 After setting, press and hold <b>BAND/SETUP</b> for at least 2 seconds. The screen returns to the previous one.</li> </ol>	<p> Page 23</p>
About REAR SELECTOR	The REAR SELECTOR function which switches the source of the rear monitor is allowed to set while driving.	 Page 26
Blackout Mode On and Off	When using the head unit Blackout function, the main unit switches and input indicators illumination will be turned OFF.	 Page 31

# Setup

## About the Setup

There are a number of setup functions available in the TMI-M990.

- For example, a sound is made when a switch is pressed, or a beep sound can be set ON/OFF when a command is received. In this way, you can change your preferred settings. (See page 34)

### <Setup menu chart>

Setting item	Setting content	Page
Picture brightness adjustment	BRIGHT $\pm 0$ (-15~+15)	36
Picture color adjustment*1	COLOR $\pm 0$ (-15~+15)	36
Picture tint adjustment*1	TINT $\pm 0$ (G15~R15)	37
Display contrast adjustment	CONTRAST $\pm 0$ (-15~+15)	37
Picture sharpness adjustment*1	SHARPNESS $\pm 0$ (-15~+15)	37
Store the image adjustments	V.EQ MEMORY <b>USER1/USER2</b>	38
Illumination brightness setting	DIMMER <b>ON/OFF/(AUTO)</b> *2	38
Illumination level setting	DIMMER Lvl. $\pm 0$ (-2~+2)	39
Display brightness adjustment	BACKLIGHT DIMMER <b>AUTO/OFF</b>	39
Automatic display opening/closing	AUTO OPEN <b>AUTO/CLOSE/OFF</b>	39
Adjusting the display back and forwards	SLIDE <b>BACK/FRONT</b>	40
Adjusting the display angle	TILT <b>1-10</b>	40
External input setting	AUX IN1, 2, 3 SIG. <b>ON/OFF</b> *3	44
AUX 1,2,3 display change setting	NAME <b>AUX-1, (2, 3)/DVD/VCR/GAME/TV/CAMERA</b> *4	45
External input audio level setting*5	INPUT GAIN <b>HIGH/LOW</b>	45
S video input setting	S-IN SIG. <b>ON/OFF</b> *6	45
S-IN display change setting	NAME <b>DVD/VCR/GAME/TV/AUX</b>	45
Operation sound setting	BEEP <b>ON/OFF</b>	41
Illumination color setting	ILLUMINATION <b>BLUE/GREEN/AMBER/(AUTO)</b> *2	41
Navigation interruption mode setting	NAVI INT. <b>AUTO/VOICE/OFF</b>	41
Navigation voice interrupt volume adjustment*7	NAVI MIX LEVEL <b>+7</b> (OFF, +1~+15)	42
Head unit link function*7	BUS AUTO <b>OFF/ON/AUTO</b>	42

**Bold** indicates the factory setting positions.

\*1 Cannot be set in the RGB Navigation mode.

\*2 AUTO is displayed only when an IONBUS compatible head unit is connected. The factory setting position is AUTO.

\*3 The factory setting position for AUX IN2 anEVEL

# Setup

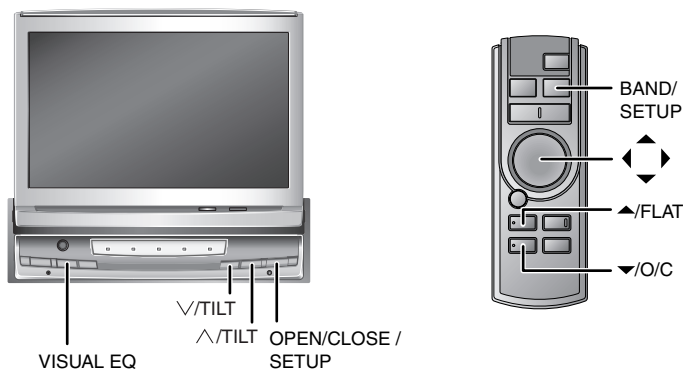

## General Setup Operation

### To display the Setup screen:

To watch a video source, your vehicle must be parked with the ignition key in the ACC or ON position. To do this, follow the procedure below.

1. Bring your vehicle to a complete stop at a safe location. Engage the parking brake.
  2. Keep pushing the foot brake and release the parking brake once then engage it again.
  3. When the parking brake is engaged for the second time, release the foot brake.
- For automatic transmission vehicles, place the transmission lever in the Park position.

Now, the locking system for the Setup operation has been released. Engaging the parking brake can reactivate the Setup, as long as the car's ignition has not been turned off. It is not necessary to repeat the above procedure (1 through 3), of "To display the Setup screen." Each time the ignition is turned OFF, perform the procedure of "To display the Setup screen."



# Setup

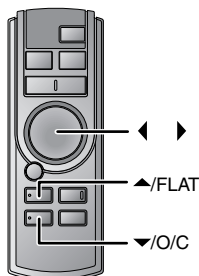

Before performing each setting, please refer to "Setup menu chart" on page 33 and "GENERAL setup standard operation" on page 35.

## Adjusting Brightness

**Setting item:** *BRIGHT*  
**Setting content:** *-15 ~ +15*



- 1 Adjust the brightness from  $-15$  to  $+15$  by pressing  $\nabla$ /TILT or  $\wedge$ /TILT.

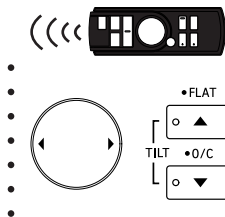

## Adjusting Color of Picture

**Setting item:** *COLOR*  
**Setting content:** *-15 ~ +15*



- 1 Adjust the color from  $-15$  to  $+15$  by pressing  $\nabla$ /TILT or  $\wedge$ /TILT.

- Color adjustment cannot be made if a Navigation system with the RGB feature is connected.

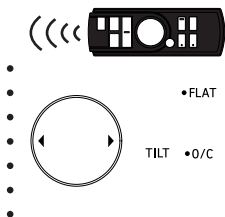

## Adjusting Tint of Picture

**Setting item:** TINT

**Setting content:** G15 ~ R15



- 1 Adjust the tint from G15 to R15 by pressing  $\nabla$  / TILT or  $\wedge$  / TILT.

- Tint adjustment cannot be made if a Navigation system with the RGB feature is connected.

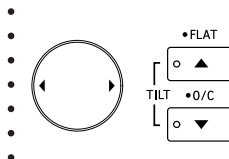

## Adjusting Display Contrast

You can adjust the display contrast for better visibility.

**Setting item:** CONTRAST

**Setting content:** -15 ~ +15



- 1 Adjust the contrast from -15 to +15 by pressing  $\nabla$  / TILT or  $\wedge$  / TILT.

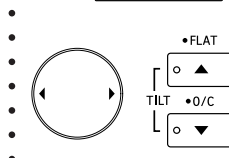

## Adjusting the Sharpness

**Setting item:** SHARPNESS

**Setting content:** -15 ~ +15



- 1 Adjust the sharpness from -15 to +15 by pressing  $\nabla$  / TILT or  $\wedge$  / TILT.

When decreasing sharpness, the image softens.  
When increasing sharpness, the image sharpens.

- Sharpness adjustment cannot be made if a Navigation system with the RGB feature is connected.

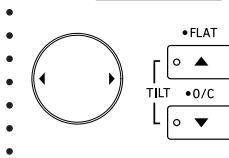



## Setting the Illumination Brightness

When the lights are switched on at night etc., the switch and Input indicator brightness of the TMI-M990 can be dimmed.

**Setting item:** *DIMMER*

**Setting content:** *ON/OFF/AUTO*

- ON: The switch and Input indicator brightness of the TMI-M990 change to the value set in “Adjusting the Illumination Level” (refer to page 39).
- OFF: The illumination brightness does not change.
- AUTO\*: When the car lights are switched ON, the switch and Input indicator brightness on the TMI-M990 become dimmer. The brightness changes to the value set in “Adjusting the Illumination Level” (refer to page 39).

\* Can only be set when connected to an IONBUS compatible head unit. Does not operate when the head unit illumination cable is not connected.

## Adjusting the Illumination Level

The switch and Input indicator brightness of the TMI-M990 can be adjusted on the TMI-M990. For example, used when slightly adjusting the brightness while driving at night etc..

**Setting item:** *DIMMER Lvl.*

**Setting content:** *-2 ~ +2*



- 1 The illumination dimmer level can be adjusted by pressing  $\nabla$  / **TILT** or  $\blacktriangle$  / **TILT**.  
-2 ~ +2: When adjusting in a minus direction, the illumination becomes darker. When adjusting in a plus direction, the illumination becomes brighter.

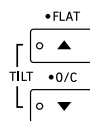

## Illumination Control

The back light (fluorescent light) built in the liquid crystal panel is switched to the brightness of the car inside to be easy to be seen.

**Setting item:** *BACKLIGHT DIMMER*

**Setting content:** *AUTO/OFF*

- AUTO:** Adjust the brightness of the background illumination of the monitor automatically to the brightness of the car inside.
- OFF:** Deactivate Auto Dimmer mode to keep the background illumination of the monitor bright.

## Setting Automatic Opening/Closing of the Monitor

**Setting item:** *AUTO OPEN*

**Setting content:** *OFF/AUTO/CLOSE*

- OFF:** The monitor is manually opened or closed by pressing OPEN/CLOSE / SETUP.
- AUTO:** The display automatically opens/closes depending on the status of the ignition key (engine key).
- CLOSE:** The monitor automatically closes when the ignition key is turned OFF. (The monitor can be opened manually by pressing OPEN/CLOSE / SETUP.)



# Setup

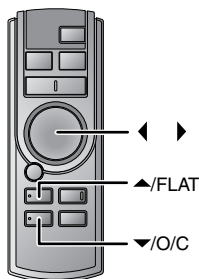

Before performing each setting, please refer to “Setup menu chart” on page 33 and “GENERAL setup standard operation” on page 35.

## Selecting the Monitor Opening Angle

**Setting item:** SLIDE

**Setting content:** BACK/FRONT

- For details, see “Adjusting the Display Back and Forwards”, page 13.

## Adjusting the Monitor Viewing Angle

**Setting item:** TILT

**Setting content:** 1 ~ 10



- 1 Press ▼ / TILT or ▲ / TILT and adjust to an angle (10 levels) that is easily viewable.

- The display angle can be adjusted by pushing the main unit switches ▼ / TILT or ▲ / TILT, or the remote control switches ▼ / TILT or ▲ / TILT. For details, see “Adjusting the Monitor Viewing Angle”, page 14.

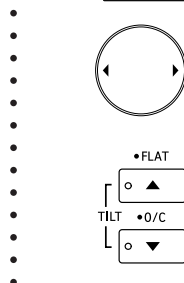

## Sound (Beep) Guide Function

**Setting item:** *BEEP*

**Setting content:** *ON/OFF*

ON: Activate the Sound Guide mode.

OFF: Deactivate the Sound Guide mode. The sound guide beep will not be produced when a button on the unit is pressed.

## Changing Lighting Color

The illumination color of the switch and Input indicators of the TMI-M990 can be selected from one of three colors. Also, if connected with the IONBUS compatible head unit (DVI-9990), the head unit illumination color can be linked.

**Setting item:** *ILLUMINATION*

**Setting content:** *BLUE/GREEN/AMBER/AUTO*

BLUE\*<sup>1</sup>: The illumination is set to BLUE.

GREEN\*<sup>1</sup>: The illumination is set to GREEN.

AMBER\*<sup>1</sup>: The illumination is set to AMBER.

AUTO\*<sup>2</sup>: The illumination automatically changes to the color set in the head unit.

\*<sup>1</sup> When an IONBUS compatible head unit is connected, the head unit illumination color is linked to the setting above.

\*<sup>2</sup> Auto is valid if connected with the IONBUS compatible head unit (DVI-9990).

## Navigation Interruption

With an Alpine navigation system connected to the TMI-M990, the voice guidance of the navigation system will be mixed with the external input such as DVD play.

**Setting item:** *NAVI INT.*

**Setting content:** *AUTO/VOICE/OFF*

AUTO: The navigation picture and voice guidance interrupt.

VOICE: Only the voice interrupts.

OFF: The navigation interruption mode is turned off.

# Setup

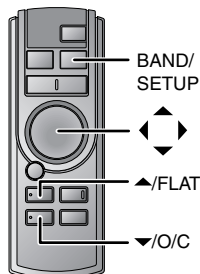
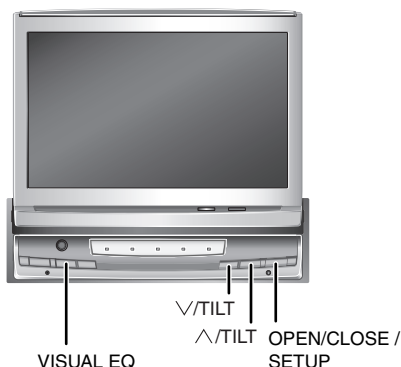

Before performing each setting, please refer to "Setup menu chart" on page 33 and "GENERAL setup standard operation" on page 35.

## Navigation Audio Interruption Volume Adjustment

You can adjust the volume level of the voice guidance.

**Setting item:** *NAVI MIX LEVEL*

**Setting content:** *+ 7 (OFF, +1~+15)*

- Can only be set when an IONBUS compatible head unit is connected.

## Head Unit Linked Functions

The simultaneous operation on the main unit can be linked to IONBUS compatible head unit source switching and cleared.

**Setting item:** *BUS AUTO*

**Setting content:** *OFF/ON/AUTO*

- OFF:** The main unit performs normal simultaneous operation.
- ON:** Simultaneous function is performed when the video is in navigation mode only. When the source is other video sources, the main unit simultaneous operation is cleared linking to the source switching of the head unit.
- AUTO:** The main unit simultaneous operation is cleared linking to the source switching of the head unit.

- Can only be set when an IONBUS compatible head unit is connected.
- For information on the simultaneous function, see "Switching the Visual Source Only (Simultaneous Function)", page 30.

# AUX IN/S-IN SETUP

The following steps 1 to 6 are for the standard AUX IN/S-IN setup. For details on the setup item details, see each setting item.

## < AUX IN/S-IN setup standard operation >



- 1** Press and hold **OPEN/CLOSE / SETUP** for at least 2 seconds.  
The GENERAL SETUP screen is displayed.

- 
- 2** Press **OPEN/CLOSE / SETUP** or **VISUAL EQ**, and select the preferred item setting from AUX IN 1, 2, 3 SIG. or S-IN SIG.  
When you press OPEN/CLOSE / SETUP, you move to the next item, press VISUAL EQ to move to the previous item.

- 
- 3** Press **∇ / TILT** or **∧ / TILT**.  
The AUX IN 1, 2, 3 or S-IN SETUP screen is displayed.

<AUX IN1 SETUP screen example>

# Setup

- 4 Press **VISUAL EQ** or **OPEN/CLOSE / SETUP**, and select the preferred item setting. When you press **OPEN/CLOSE / SETUP**, you move to the next item, press **VISUAL EQ** to move to the previous item.

- 5 Change the setting by pressing  $\nabla$  / **TILT** or  $\blacktriangle$  / **TILT**.

- 6 To return to the **GENERAL SETUP** screen, press  $\nabla$  / **TILT** or  $\blacktriangle$  / **TILT** after selecting **RETURN**. To exit the setup, press and hold **OPEN/CLOSE / SETUP** for at least 2 seconds.

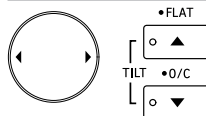
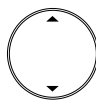

- To return to the **GENERAL SETUP** screen, select **RETURN**.

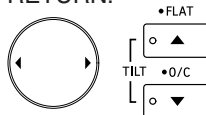

- To exit the setup:



Before performing each setting, please refer to “Setup menu chart” on page 33 and “AUX IN/S-IN setup standard operation” on page 43.

## Setting the AUX Mode

**Setting item:** *AUX IN 1, 2, 3, SIG.*

**Setting content:** *ON/OFF*

ON: AUX source is displayed.

OFF: AUX source is not displayed.

## Name External Equipment to Be Displayed (AUX)

When at least one external device is connected, you can name each as you like.

**Setting item:** *NAME*

**Setting content:** *AUX-1, (2, 3)/DVD/VCR/GAME/TV\*1/CAMERA\*2*

\*1 To connect with a TV unit, refer to “TV Operation” page 46.

\*2 CAMERA is only displayed in AUX-3 mode. Set to camera when the back camera is connected.

- Can be only when AUX IN 1, 2, 3 SIG. is ON.

## External Input Audio Level Adjustment

**Setting item:** *INPUT GAIN*

**Setting content:** *HIGH/LOW*

HIGH: Set external input audio level to high.

LOW: Set external input audio level to low.

- Can be set when AUX IN 1,2,3 SIG. ON.
- Cannot be set to LOW, when the system switch is set to STANDALONE. (Refer to “About the system switch” (page 54).)

## Setting the S-IN Mode

**Setting item:** *S-IN SIG.*

**Setting content:** *ON/OFF*

ON: Display S video output compatible ALPINE head unit source.

OFF: Do not display S video output compatible ALPINE head unit.

- Set when connecting to a S video output compatible head unit.
- You cannot set to OFF when connected to an IONBUS compatible head unit.
- If connected with a DVI-9990, set “Changing Video Output” on the S-VIDEO of DVI-9990. For details, refer to the DVI-9990 instructions manual.

## Name the S Video Input to Be Displayed (S-IN)

If a S video output compatible ALPINE head unit is connected, you can attach a display name you like.

**Setting item:** *NAME*

**Setting content:** *AUX/DVD/VCR/GAME/TV*

- Only valid when S-IN SIG. is ON.
- Not displayed when changing the source.  
You can check the display by pressing **DISP/A.MEMO** on the remote control.

# TV (Optional)

## TV Operation

When connected with a TV unit (sold separately), you can use the remote control supplied with the TMI-M990 to operate the TV. Set the AUX NAME to TV. Refer to (Setup “Name External Equipment to Be Displayed (AUX)” page 45).

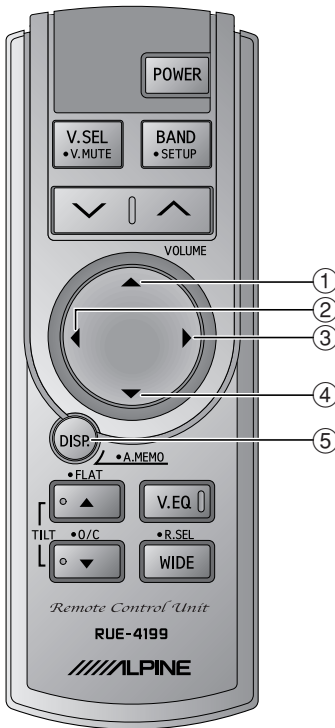

- ① ▲ Button  
Preset selection UP
- ② ◀ Button  
Channel station selection DOWN  
Long press for automatic selection
- ③ ▶ Button  
Channel station selection UP  
Long press for automatic selection
- ④ ▼ Button  
Preset selection DOWN
- ⑤ DISP/A.MEMO Button  
Check channel no.  
Long press for auto memory

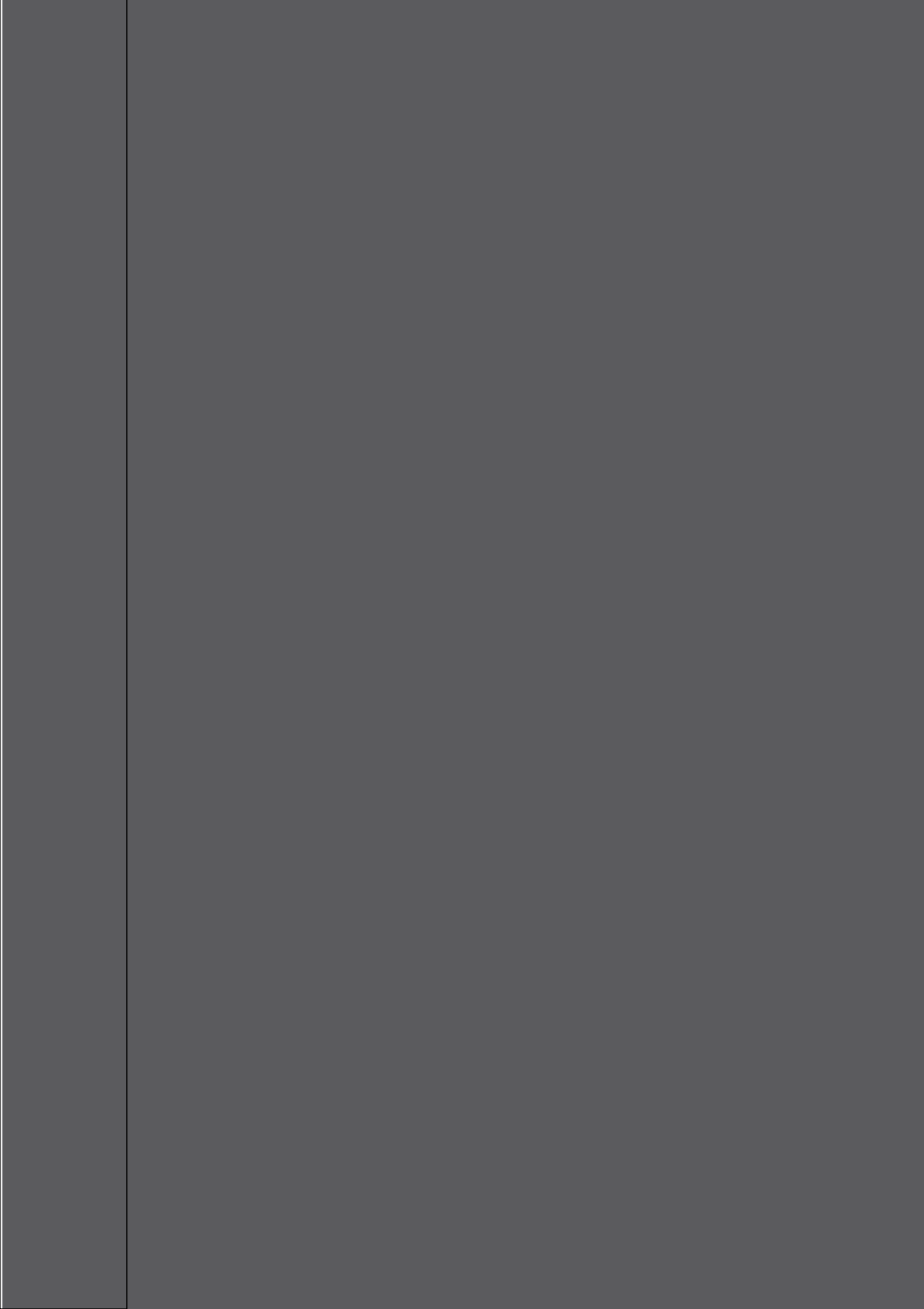



# Operating from the Head Unit

## Operating the Head Unit with the Remote Control

The main unit can be operated with the remote control supplied with the head unit.

### ● Remote control operation list

RUE-4196

	Operation explanation	Page
⏪ ⏩*	Channel selection etc. Press and hold for automatic channel selection.	—
▲ ▼*	Preset selection etc.	—
▶/  *	Auto memory	—
A.PROC.	Switch display mode	17
	Press and hold to access/exit the REAR SELECTOR screen.	26
BAND*	Switching the TV band	—
Joystick	Press ↑, ↓ to select the adjusting items. Press ←, → to adjust the item and/or change the setting.	23, 26, 34, 42
TITLE	Accessing VISUAL EQ mode	20
	Press and hold to access/exit the VISUAL EQ SETUP screen.	23
V.SEL.	Switch V. SEL (Simultaneous Function)/In the VISUAL EQ SETUP screen, the adjusted VISUAL EQ value is stored.	—
	Press and hold to turn the backlight off/on.	31
■*	Switches the power of the TV Tuner ON/OFF	—
MENU/SETUP	Press and hold down continuously to access/exit the SETUP screen.	33
TOP.M/DISP	Video source, display mode, etc. indication.	27
	Long press for auto memory**.	—
DEL.*	Switches between stereo/MONO/SAP.	—
ten key*	Tuning stations directly.	—
+10	Press and hold to open/close the display.	12
AUDIO	Display angle <b>DOWN</b>	14, 40
	Press and hold to open/close the display.	12
ANGLE	Display angle <b>UP</b>	14, 40
	Press and hold to make the display go flat.	15
SUBT.	Adjusting the display back and forwards	13, 40

\* Valid when connected with a TV unit (sold separately).

\*\* Depending on the TV unit connected.

- Change the switch on the back of the remote control to “TV.MONI” and operate.

## In Case of Difficulty

If you encounter a problem, please turn the power off, then on again. If the unit is still not functioning normally, please review the items in the following checklist. This guide will help you isolate the problem if the unit is at fault. Otherwise, make sure the rest of your system is properly connected, or then consult your authorized Alpine dealer.

### No function or display.

- Vehicle's ignition is off.
  - If connected according to the instructions, the unit will not operate with the vehicle's ignition off.
- Improper power lead connections.
  - Check power lead connections.
- Blown fuse.
  - Check the fuse on the battery lead of the unit; replace with the proper value if necessary.
- Internal micro-computer malfunctioned due to interference noise, etc.
  - Press the RESET switch with a ballpoint pen or other pointed article.

### No sound or unnatural sound.

- Incorrect setting of volume control.
  - Readjust the controls.
- Connections are not properly or securely made.
  - Check the connections and firmly connect.

### Unclear picture display.

- Fluorescent tube is exhausted.
  - Replace the fluorescent tube\*.

\*The fluorescent tube replacement is not free of charge even within the warranty period, for the tube is an article of consumption.

### Screen not displayed.

- Brightness control is set at the minimum position.
  - Adjust the Brightness control.
- Temperature in the vehicle is too low.
  - Increase the vehicle's interior temperature to operation temperature range.
- Connections to the DVD, CD player, navigation system are not securely made.
  - Check the connections and firmly connect.

### Movement of displayed picture is abnormal.

- Temperature in the vehicle is too high.
  - Allow the vehicle's interior temperature to cool.

### Unclear or noisy display.

- Fluorescent plate is worn out.
  - Replace the fluorescent plate.

### Navigation system inoperative.

- Connections to the navigation system are incorrect.
  - Check the connections with the navigation system and connect the cables correctly and firmly.

### Indication

#### HI-TEMP

- Protective circuit is activated due to high temperature.
  - Leave the power OFF until the temperature decreases and then turn the power ON again.

## Specifications

### MONITOR SECTION

Screen Size	7.0"
LCD Type	Transparent type TN LCD
Operation System	Low temperature p-si TFT active matrix
Number of Picture Elements	1,152,000 pcs. (2,400 x 480)
Effective Number of Picture Elements	99.99% or more
Illumination System	Cold cathode fluorescent tube

### AV-INTERFACE UNIT SECTION

S/N Ratio	
Video	40dB
Audio	50dB
Input Level	
Video	1 V <sub>p-p</sub> (75Ω UNBALANCED)
Audio	1200mV (RMS)
Output Level	
Video	1 V <sub>p-p</sub> (75Ω UNBALANCED)
Audio*	425mV (RMS) (AUX1 when the system switch is set to STANDALONE (VOL MAX))
	1200mV (RMS) (AUX1, AUX2 when the system switch is set to SYSTEM)

\*AUX OUT level: when the AUX IN level is 1200mV (RMS).

### REMOTE CONTROL

Battery Type	AAA batteries (2 pcs.)
Width	42 mm (1-21/32")
Height	121 mm (4-25/32")
Depth	23 mm (29/32")
Weight	50 g (1.8 oz)

### GENERAL

Power Requirement	14.4V DC (11-16 V allowable)
Operating temperature	+32°F to +113°F (0°C to + 45°C)
Weight	
(Monitor Section)	1.7 kg (3 lbs. 12 oz)
(AV-Interface Unit Section)	530g (1 lb. 3 oz)

### CHASSIS SIZE (Monitor section)

Width	178 mm (7")
Height	50 mm (2")
Depth	165 mm (6-1/2")

### CHASSIS SIZE (AV-Interface Unit section)

Width	160 mm (5-5/16")
Height	40 mm (1-9/16")
Depth	120 mm (4-3/4")

- Due to continuous product improvement, specifications and design are subject to change without notice.
- The LCD panel is manufactured using an extremely high precision manufacturing technology. Its effective pixel ratio is over 99.99%. This means that there is a possibility that 0.01% of the pixels could be either always ON or OFF.

# Installation and Connections

Before installing or connecting the unit, please read the following and pages 3 to 5 of this manual thoroughly for proper use.

## **Warning**

---

### **MAKE THE CORRECT CONNECTIONS.**

Failure to make the proper connections may result in fire or product damage.

---

### **USE ONLY IN CARS WITH A 12 VOLT NEGATIVE GROUND.**

(Check with your dealer if you are not sure.) Failure to do so may result in fire, etc.

---

### **BEFORE WIRING, DISCONNECT THE CABLE FROM THE NEGATIVE BATTERY TERMINAL.**

Failure to do so may result in electric shock or injury due to electrical shorts.

---

### **DO NOT ALLOW CABLES TO BECOME ENTANGLED IN SURROUNDING OBJECTS.**

Arrange wiring and cables in compliance with the manual to prevent obstructions when driving. Cables or wiring that obstruct or hang up on places such as the steering wheel, gear lever, brake pedals, etc. can be extremely hazardous.

---

### **DO NOT SPLICE INTO ELECTRICAL CABLES.**

Never cut away cable insulation to supply power to other equipment. Doing so will exceed the current carrying capacity of the wire and result in fire or electric shock.

---

### **DO NOT DAMAGE PIPE OR WIRING WHEN DRILLING HOLES.**

When drilling holes in the chassis for installation, take precautions so as not to contact, damage or obstruct pipes, fuel lines, tanks or electrical wiring. Failure to take such precautions may result in fire.

---

### **DO NOT USE BOLTS OR NUTS IN THE BRAKE OR STEERING SYSTEMS TO MAKE GROUND CONNECTIONS.**

Bolts or nuts used for the brake or steering systems (or any other safety-related system), or tanks should NEVER be used for installations or ground connections. Using such parts could disable control of the vehicle and cause fire etc.

---

### **KEEP SMALL OBJECTS SUCH AS BOLTS OR SCREWS OUT OF THE REACH OF CHILDREN.**

Swallowing them may result in serious injury. If swallowed, consult a physician immediately.

---

### **DO NOT INSTALL IN LOCATIONS WHICH MIGHT HINDER VEHICLE OPERATION, SUCH AS THE STEERING WHEEL OR GEARSHIFT.**

Doing so may obstruct forward vision or hamper movement etc. and results in serious accident.

# Installation and Connections

## **Caution**

### **HAVE THE WIRING AND INSTALLATION DONE BY EXPERTS.**

The wiring and installation of this unit requires special technical skill and experience. To ensure safety, always contact the dealer where you purchased this product to have the work done.

### **USE SPECIFIED ACCESSORY PARTS AND INSTALL THEM SECURELY.**

Be sure to use only the specified accessory parts. Use of other than designated parts may damage this unit internally or may not securely install the unit in place. This may cause parts to become loose resulting in hazards or product failure.

### **ARRANGE THE WIRING SO IT IS NOT CRIMPED OR PINCHED BY A SHARP METAL EDGE.**

Route the cables and wiring away from moving parts (like the seat rails) or sharp or pointed edges. This will prevent crimping and damage to the wiring. If wiring passes through a hole in metal, use a rubber grommet to prevent the wires insulation from being cut by the metal edge of the hole.

### **DO NOT INSTALL IN LOCATIONS WITH HIGH MOISTURE OR DUST.**

Avoid installing the unit in locations with high incidence of moisture or dust. Moisture or dust that penetrates into this unit may result in product failure.

## **Precautions**

- Be sure to disconnect the cable from the (-) battery post before installing your TMI-M990. This will reduce any chance of damage to the unit in case of a short-circuit.
- Be sure to connect the color coded leads according to the diagram. Incorrect connections may cause the unit to malfunction or damage to the vehicle's electrical system.
- When making connections to the vehicle's electrical system, be aware of the factory installed components (e.g. on-board computer). Do not tap into these leads to provide power for this unit. When connecting the TMI-M990 to the fuse box, make sure the fuse for the intended circuit of the TMI-M990 has the appropriate amperage. Failure to do so may result in damage to the unit and/or the vehicle. When in doubt, consult your ALPINE dealer.
- The TMI-M990 uses female RCA-type jacks for connection to other units (e.g. amplifier) having RCA connectors. You may need an adaptor to connect other units. If so, please contact your authorized ALPINE dealer for assistance.
- The Display must be completely retracted in the casing when installing. If it is not, problems may occur.
- When installing in automobiles, make sure the Display can open/close without coming in contact with the gear shift.

## **IMPORTANT**

Please record the serial number of your unit in the space provided below and keep it as a permanent record. The serial number plate is located on the bottom of the unit.

SERIAL NUMBER: \_\_\_\_\_  
INSTALLATION DATE: \_\_\_\_\_  
INSTALLATION TECHNICIAN: \_\_\_\_\_  
PLACE OF PURCHASE: \_\_\_\_\_

# Installation

## Installing the Monitor

### Installation Location

Before deciding on the mounting location, check that opening and closing the display will not hamper gear shifting in that position.

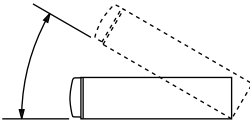

- Install at an angle of within 30 degrees from the horizontal.

1

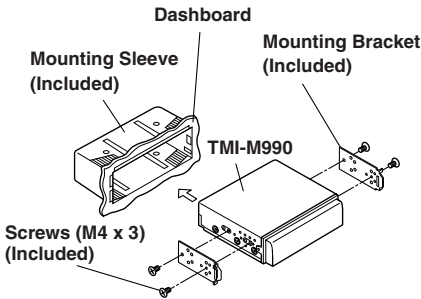

Slide the mounting sleeve into the dashboard. Install the supplied bracket on the monitor.

- Make sure to use the supplied screw (M4 x 3) to install the monitor. If you use another screw to install the monitor, it may cause a malfunction.

2

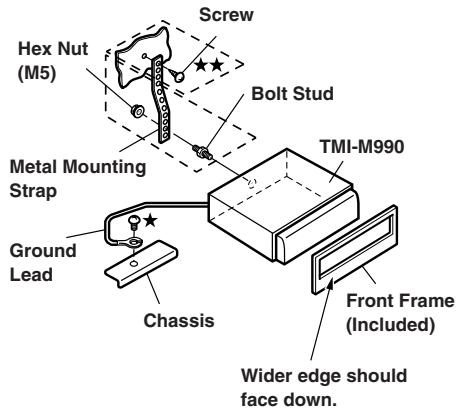

Reinforce the monitor unit with a metal mounting strap (not supplied). Secure the ground lead of the unit to a clean metal spot using a screw (★) already attached to the vehicle's chassis.

- For the screw marked ★★, use an appropriate screw for the chosen mounting location.

Continued

# Installation and Connections

3

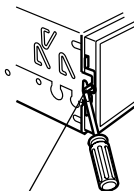

Lock Pin

Slide the TMI-M990 into the dashboard. When the unit is in place, make sure the locking pins are fully seated in the down position. This can be done by pressing firmly in on the unit while pushing the locking pin down with a small screwdriver. This ensures that the unit is properly locked and will not accidentally come out from the dashboard. Install the supplied Front Frame.

## Removal

1. Use a small screwdriver (or similar tool) to push the locking pins to the "up" position (see Step 3). As each pin is unlocked, gently pull out on the unit to make sure it does not re-lock before unlocking the second pin.
2. Pull the unit out, keeping it unlocked as you do so.

## < JAPANESE CAR >

To install using the vehicle's standard bracket.

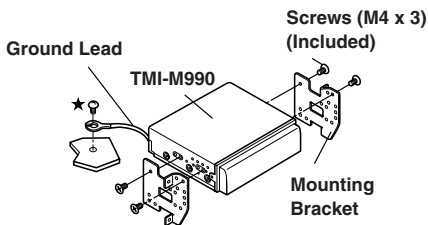

- Make sure to use the supplied screw (M4 x 3) to install the monitor. If you use another screw to install the monitor, it may cause a malfunction.

## Installing the AV-Interface Unit

When mounting the unit with the Velcro fasteners, be sure to choose a flat location.

Do not hang the unit from the bottom of the dashboard or rear deck with the Velcro fasteners.

- 1 Remove the Protective paper and attach two pieces of Velcro fastener to the bottom of the AV-Interface Unit.

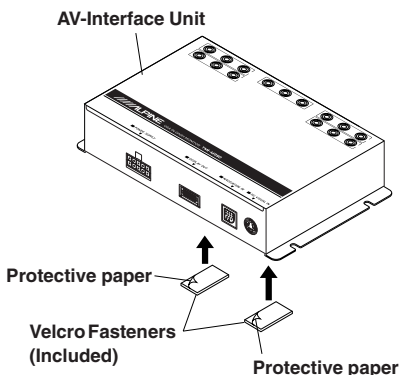

- 2 Check the position, and then fix the unit to the floor carpet.

## About the system switch

It is necessary to change the system switch before installing this unit.

- Change to "1:SYSTEM" when the TMI-M990 is connected with an IONBUS compatible head unit.
- When not connected to an IONBUS compatible head unit, change to "2:STANDALONE".

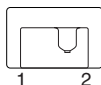

1:SYSTEM  
2:STANDALONE  
(Initial Setting)

<Monitor bottom side>

- Be sure to turn the power off to the unit before changing the switch position.

# Parking Brake Lead Connection

If necessary, use a pinch connector to connect the foot brake lead, parking brake lead, etc.

1

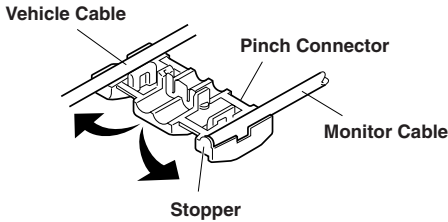

2

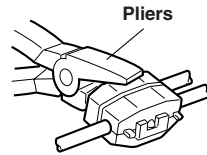

## Foot Brake Lead / Parking Brake Lead Connection

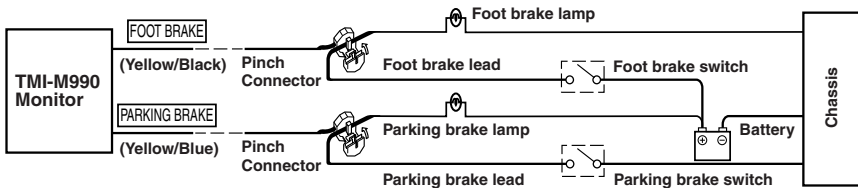

## Connection Diagram of SPST Switch (Sold Separately)

(If the ACC power supply is not available)

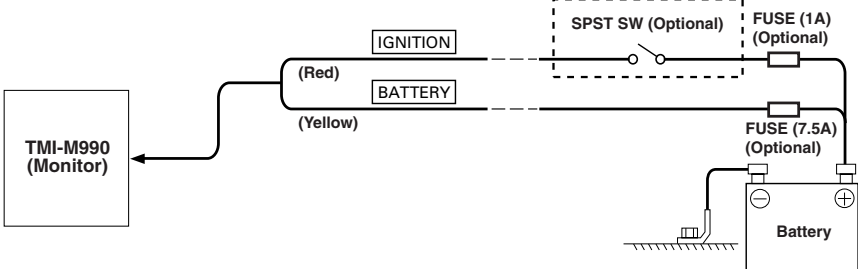

- If your vehicle has no ACC power supply, add an SPST (Single-Pole, Single-Throw) switch (sold separately) and fuse (sold separately).
- The diagram and the fuse amperage shown above are in the case when TMI-M990 is used individually.
- If the switched power (ignition) lead of the TMI-M990 is connected directly to the positive (+) post of the vehicle's battery, the TMI-M990 draws some current (several hundred milliamperes) even when its switch is placed in the OFF position and the battery may be discharged.



# Installation and Connections

## Connections (TMI-M990 Wiring Diagram)

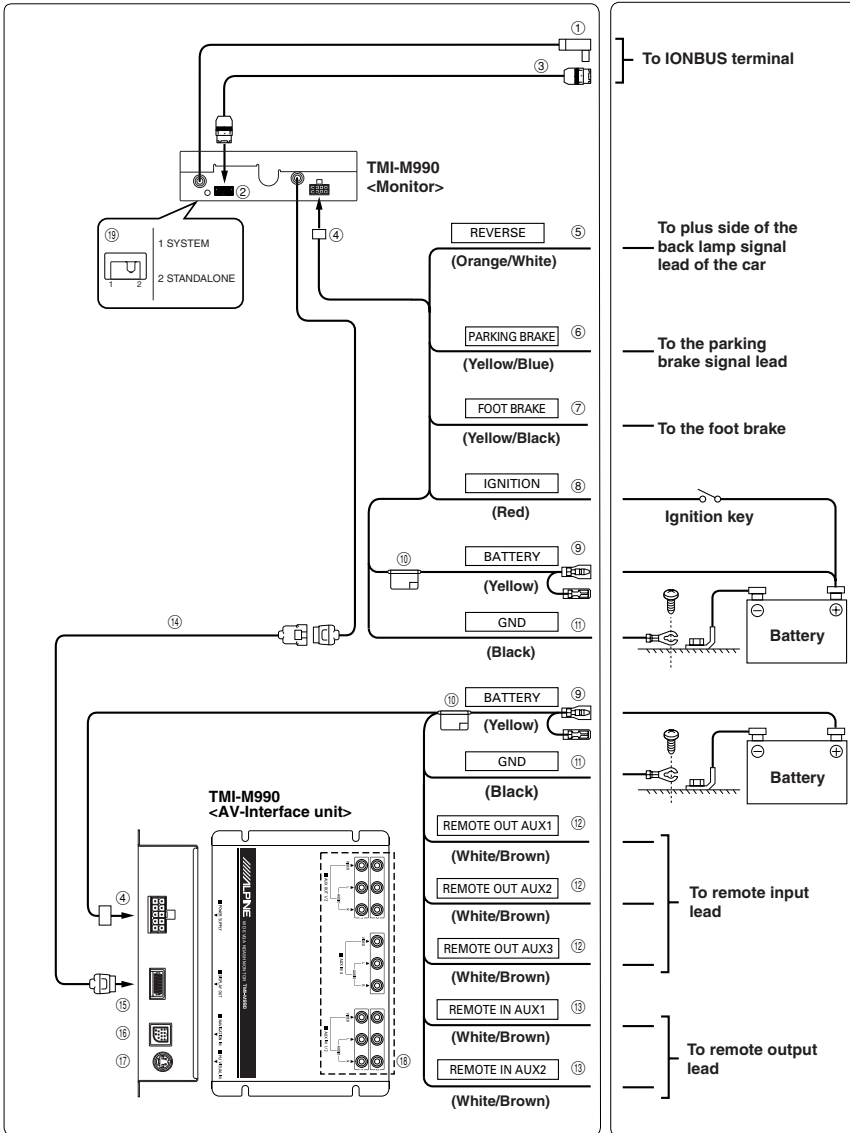

- ① **IONBUS cable**  
Used when setting up IONBUS compatible products.
- ② **IONBUS terminal**  
Used when setting up IONBUS compatible products.
- ③ **IONBUS cable (Included)**
- ④ **Power Supply Connector (Included)**
- ⑤ **Reverse Lead (Orange/White)**  
Use only when a back-up camera is connected. Connect to the plus side of the car's reverse lamp that lights when the transmission is shifted into reverse (R). Switches the video picture to the back-up camera. This is linked with putting the car into reverse (R).
- ⑥ **Parking Brake Lead (Yellow/Blue)**  
Connect this lead to the power supply side of the parking brake switch to transmit the parking brake status signals to the TMI-M990.
- ⑦ **Foot Brake Lead (Yellow/Black)**  
Connect to the vehicle's foot brake lead or brake lamp lead.
- ⑧ **Switched Power Lead (Ignition) (Red)**  
Connect this lead to an open terminal on the vehicle's fuse box or another unused power source which provides (+) 12V only when the ignition is turned on or in the accessory position. When connecting with the IONBUS compatible head unit, do not connect the ignition lead.
- ⑨ **Battery Lead (Yellow)**  
Connect this lead to the positive (+) post of the vehicle's battery.
- ⑩ **Choke Coil with Fuse Holder (7.5A)**
- ⑪ **Ground Lead (Black)**  
Connect this lead to a good chassis ground on the vehicle. Make sure the connection is made to bare metal and is securely fastened using the sheet metal screw provided.
- ⑫ **Remote Control Output Lead (White/Brown)**  
Connect this lead to the remote control input lead. This lead outputs the controlling signals from the remote control.
- ⑬ **Remote Control Input Lead (White/Brown)**  
Connect the external Alpine product to the remote control output lead.
- ⑭ **Monitor Extension Cable (Included)**
- ⑮ **Display Output Terminal**
- ⑯ **RGB Input Terminal**
- ⑰ **S Video Input Terminal**
- ⑱ **AUX Input Terminals/AUX Output Terminals**
- ⑲ **System Switch**  
Change to "1:SYSTEM" when the TMI-M990 is connected with an IONBUS compatible head unit.  
When not connected to an IONBUS compatible head unit, change to "2:STANDALONE".
  - Be sure to turn the power off to the unit before changing the switch position.

# Installation and Connections

## System Example

When Connecting External Equipment (If an IONBUS Compatible Head Unit is not connected)

When the System Switch is set to “STANDALONE”

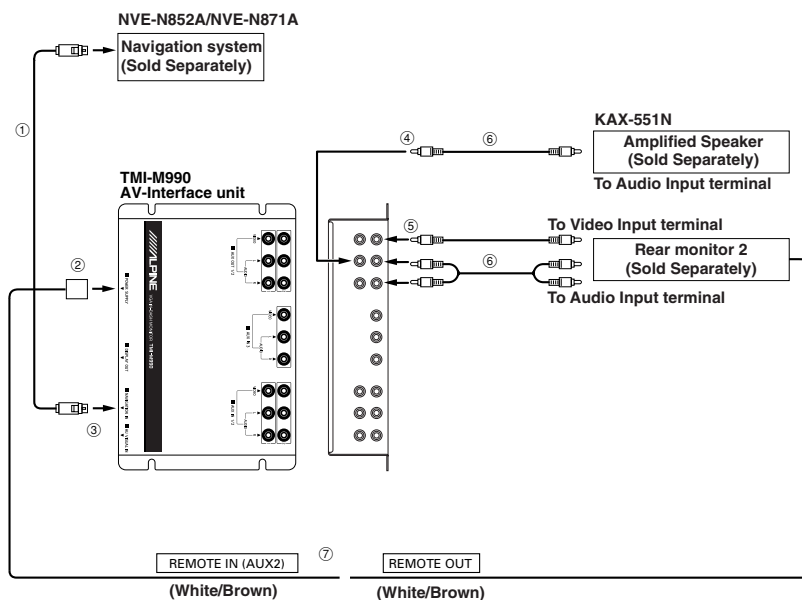

- When the NVA-N751AS is connected for the Navigation System, use the RGB conversion cable KWE-503N (Sold separately).

- ① **RGB Cable (Included with NVE-N852, not included with NVE-N871A)**
- ② **Power Supply Connector**
- ③ **RGB Input Terminal**  
Connect this to the RGB output terminal of the Navigation System.
- ④ **AUX Audio Output (AUX1) (L) Terminal**  
When the System Switch is set to STANDALONE:  
AUX1 Audio Output Terminal is used as the audio output for the main unit.  
A separately sold Amplifier Speaker (KAX-551N) is required if using this unit by itself.  
There is no output from the AUX1 Video Output Terminal.
- ⑤ **AUX Video/Audio Output (AUX2) Terminal**
- ⑥ **RCA Extension Cable (Sold separately)**
- ⑦ **Remote Control Input Lead (White/Brown)**



# Installation and Connections

## ① System Switch

Change to "1:SYSTEM" when the TMI-M990 is connected with an IONBUS compatible head unit.

When not connected to an IONBUS compatible head unit, change to "2:STANDALONE".

- Be sure to turn the power off to the unit before changing the switch position.

## ② Power Supply Connector

## ③ AUX Video/Audio Output (AUX2) Terminal

Use when connecting an optional monitor etc.

## ④ AUX Video/Audio Output (AUX1) Terminal

Use when connecting an optional monitor etc.

## ⑤ AUX Video/Audio Input (AUX1) Terminal

## ⑥ AUX Video/Audio Input (AUX2) Terminal

## ⑦ AUX Video Input (AUX3) Terminal

Use when connecting a back-up camera.

## ⑧ Remote Control Output Lead (White/Brown)

Connect this lead to the remote control input lead. This lead outputs the controlling signals from the remote control.

## ⑨ RCA Extension Cable (Sold separately)

## ⑩ Reverse Lead (Orange/White)

Connect to the plus side of the car's reverse lamp which lights when the transmission is shifted into reverse (R).

Switches the video picture to the back-up camera. This is linked to putting the car into reverse (R).

## ⑪ Remote Control Input Lead (White/Brown)

- When connecting with the IONBUS compatible head unit, do not connect the ignition lead.

## When connecting Navigation System

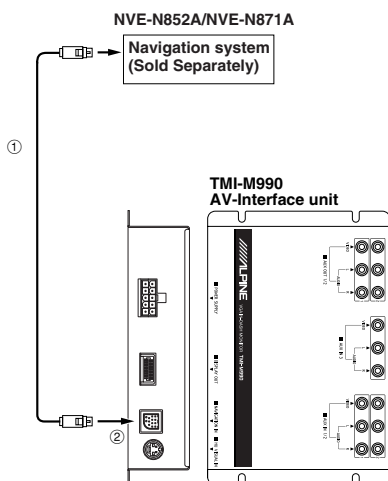

- When the NVA-N751AS is connected for the Navigation System, use the RGB conversion cable KWE-503N (Sold separately).

① **RGB Cable (Included with NVE-N852, not included with NVE-N871A)**

② **RGB Input Terminal**

Connect this to the RGB output terminal of the Navigation System.

**To prevent external noise from entering the audio system.**

- Locate the unit and route the leads at least 10 cm away from the car's electrical harness.
- Keep the battery power leads as far away from other leads as possible.
- Connect the ground lead securely to a bare metal spot (remove any paint, dirt or grease if necessary) of the car chassis.
- If you add an optional noise suppressor, connect it as far away from the unit as possible. Your Alpine dealer carries various noise suppressors, contact them for further information.
- Your Alpine dealer knows best about noise prevention measures so consult your dealer for further information.

# Installation and Connections

Connecting an IONBUS compatible head unit, an IONBUS compatible Multimedia Manager and an Ai-NET compatible CD changer

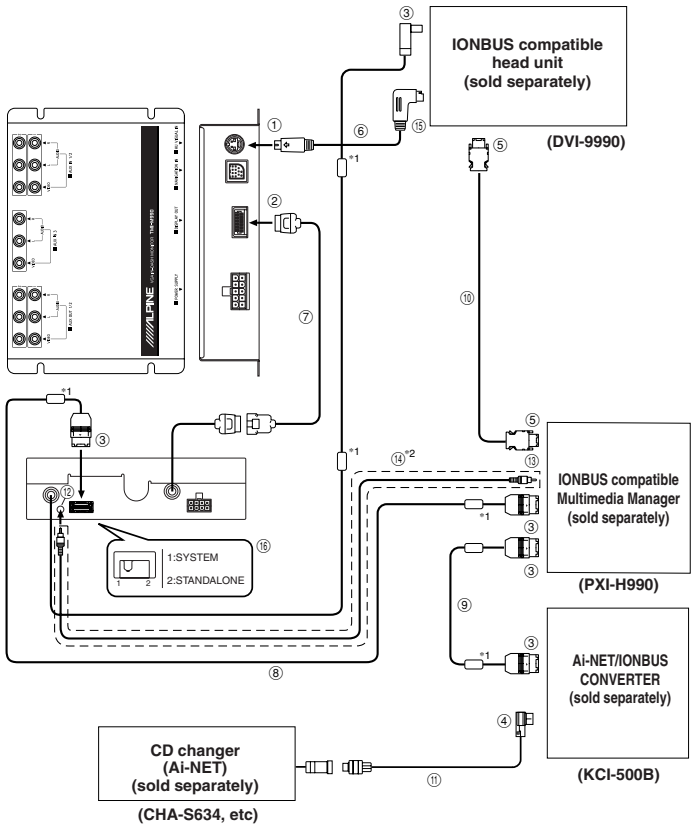

① **S Video Input Terminal**

② **Display Output Terminal**

③ **IONBUS Terminal**

④ **Ai-NET Connector**

Only an Ai-NET compatible CD changer, XM Radio Module can be connected. All other Ai-NET products are not compatible.

⑤ **DVD Audio Link Terminal**

⑥ **S Video Cable (Included with head unit)**

⑦ **Monitor Extension Cable (Included)**

⑧ **IONBUS Cable (Included)**

⑨ **IONBUS Cable (Included with CONVERTER)**

⑩ **DVD Audio Link Cable (Included with Multimedia Manager)**

⑪ **Ai-NET Cable (Included with CD changer)**

⑫ **Road EQ Microphone Terminal**

⑬ **Microphone Terminal automatic adjustment**

⑭ **Microphone Terminal Connection Cable (Included with Multimedia Manager)**

⑮ **S Video Output Terminal**

⑯ **System Switch**

Change to "1:SYSTEM" when the TMI-M990 is connected with an IONBUS compatible head unit.

\*1 Ferrite Core

Attach the Ferrite Core (included) to the both ends of the IONBUS cable at a location where the product does not touch the core when installing.

(When connecting to the main unit, attach the core at a location of approx. 10 cm from the terminal end.)

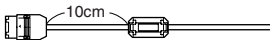

When attaching the core to the cable from the monitor main unit, also attach to the both ends.

Two pieces are attached to TMI-M990, PXI-H990, KCI-500B.

\*2 Connect only when using the Road EQ microphone built in the main unit.

- IONBUS compatible products can be connected in any order. The above connection chart is an example.
- When connecting with the IONBUS compatible head unit, do not connect the ignition lead.
- Use if connecting a KCI-500B to an Ai-NET compatible CD changer, XM Radio Module.





## LIMITED WARRANTY

ALPINE ELECTRONICS OF AMERICA, INC. AND ALPINE OF CANADA INC. ("Alpine"), are dedicated to quality craftsmanship and are pleased to offer this Warranty. We suggest that you read it thoroughly. Should you have any questions, please contact your Dealer or contact Alpine at one of the telephone numbers listed below.

### ●PRODUCTS COVERED:

This Warranty covers Car Audio Products and Related Accessories ("the product"). Products purchased in the Canada are covered only in the Canada. Products purchased in the U.S.A. are covered only in the U.S.A.

### ●LENGTH OF WARRANTY:

This Warranty is in effect for one year from the date of the first consumer purchase.

### ●WHO IS COVERED:

This Warranty only covers the original purchaser of the product, who must reside in the United States, Puerto Rico or Canada.

### ●WHAT IS COVERED:

This Warranty covers defects in materials or workmanship (parts and labor) in the product.

### ●WHAT IS NOT COVERED:

This Warranty does not cover the following:

- ① Damage occurring during shipment of the product to Alpine for repair (claims must be presented to the carrier).
- ② Damage caused by accident or abuse, including burned voice coils caused by over-driving the speaker (amplifier level is turned up and driven into distortion or clipping). Speaker mechanical failure (e.g. punctures, tears or rips). Cracked or damaged LCD panels. Dropped or damaged hard drives.
- ③ Damage caused by negligence, misuse, improper operation or failure to follow instructions contained in the Owner's manual.
- ④ Damage caused by act of God, including without limitation, earthquake, fire, flood, storms or other acts of nature.  
Any cost or expense related to the removal or reinstallation of the product.
- ⑤ Service performed by an unauthorized person, company or association.
- ⑥ Any product which has the serial number defaced, altered or removed.
- ⑦ Any product which has been adjusted, altered or modified without Alpine's consent.
- ⑧ Any product not distributed by Alpine within the United States, Puerto Rico or Canada.
- ⑨ Any product not purchased from an Authorized Alpine Dealer.

### ●HOW TO OBTAIN WARRANTY SERVICE:

- ① You are responsible for delivery of the product to an Authorized Alpine Service Center or Alpine for repair and for payment of any initial shipping charges. Alpine will, at its option, repair or replace the product with a new or reconditioned product without charge. If the repairs are covered by the warranty, and if the product was shipped to an Authorized Alpine Service Center or Alpine, Alpine will pay the return shipping charges.
- ② You should provide a detailed description of the problem(s) for which service is required.

- ⑤ You must supply proof of your purchase of the product.
- ④ You must package the product securely to avoid damage during shipment. To prevent lost packages it is recommended to use a carrier that provides a tracking service.

### ●HOW WE LIMIT IMPLIED WARRANTIES:

ANY IMPLIED WARRANTIES INCLUDING FITNESS FOR USE AND MERCHANTABILITY ARE LIMITED IN DURATION TO THE PERIOD OF THE EXPRESS WARRANTY SET FORTH ABOVE AND NO PERSON IS AUTHORIZED TO ASSUME FOR ALPINE ANY OTHER LIABILITY IN CONNECTION WITH THE SALE OF THE PRODUCT.

### ●HOW WE EXCLUDE CERTAIN DAMAGES:

ALPINE EXPRESSLY DISCLAIMS LIABILITY FOR INCIDENTAL AND CONSEQUENTIAL DAMAGES CAUSED BY THE PRODUCT. THE TERM "INCIDENTAL DAMAGES" REFERS TO EXPENSES OF TRANSPORTING THE PRODUCT TO THE ALPINE SERVICE CENTER, LOSS OF THE ORIGINAL PURCHASER'S TIME, LOSS OF THE USE OF THE PRODUCT, BUS FARES, CAR RENTALS OR OTHERS COSTS RELATING TO THE CARE AND CUSTODY OF THE PRODUCT. THE TERM "CONSEQUENTIAL DAMAGES" REFERS TO THE COST OF REPAIRING OR REPLACING OTHER PROPERTY WHICH IS DAMAGED WHEN THIS PRODUCT DOES NOT WORK PROPERLY. THE REMEDIES PROVIDED UNDER THIS WARRANTY ARE EXCLUSIVE AND IN LIEU OF ALL OTHERS.

### ●HOW STATE/PROVINCIAL LAW RELATES TO THE WARRANTY:

This Warranty gives you specific legal rights, and you may also have other rights which vary from state to state and province to province. In addition, some states/provinces do not allow limitations on how long an implied warranty lasts, and some do not allow the exclusion or limitation of incidental or consequential damages. Accordingly, limitations as to these matters contained herein may not apply to you.

### ●IN CANADA ONLY:

This Warranty is not valid unless your Alpine car audio product has been installed in your vehicle by an Authorized Installation Center, and this warranty stamped upon installation by the installation center.

### ●HOW TO CONTACT CUSTOMER SERVICE:

Should the product require service, please call the following number for your nearest Authorized Alpine Service Center.

**CAR AUDIO 1-800-ALPINE-1 (1-800-257-4631)  
NAVIGATION 1-888-NAV-HELP (1-888-628-4357)**

Or visit our website at: <http://www.alpine-usa.com>

ALPINE ELECTRONICS OF AMERICA, INC., 19145 Gramercy Place, Torrance, California 90501, U.S.A.

ALPINE ELECTRONICS OF CANADA, INC., 7300 Warden Ave., Suite 203, Markham, Ontario L3R 9Z6, Canada  
Do not send products to these addresses.

Call the toll free telephone number or visit the website to locate a service center.